

Cadre de type ajustable et grille autoblocante 585mm

Détails rebord anti-charrue

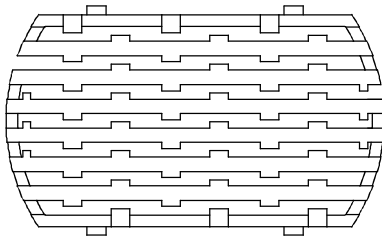

HAUTEUR	CADRE
129mm	C
205mm	D

CADRE	A	B
129mm	38mm	18mm
205mm	38mm	18mm

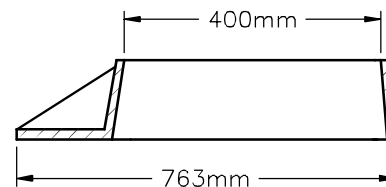
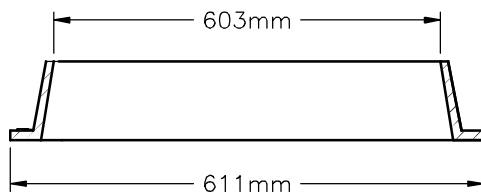
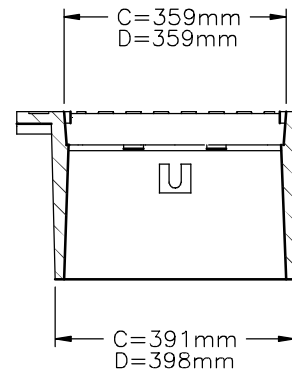
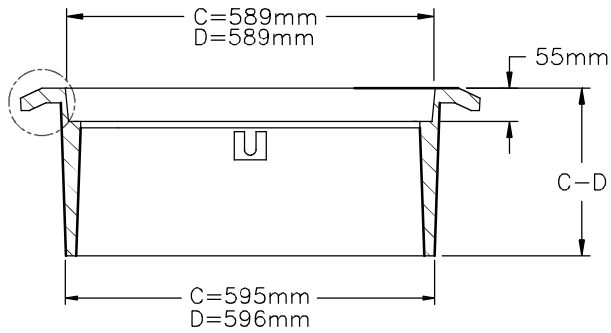
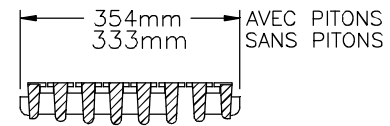
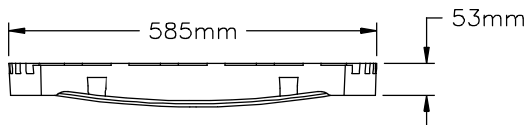
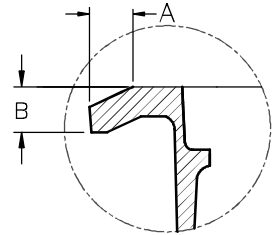

TABLEAU DES CARACTÉRISTIQUES

NO. DE PRODUIT	MATÉRIEL	POIDS KG
P-51A GRIILLE Ø585mm	FONTE DUCTILE	37 KG
P-51A CADRE AJUSTABLE 129mm DE HAUT	FONTE DUCTILE	33 KG
P-51A CADRE AJUSTABLE 205mm DE HAUT	FONTE DUCTILE	49 KG
P-51C CADRE GUIDEUR CONIQUE	FONTE GRISE	38 KG